

CE⁰¹⁹⁷

D600^{LED} ULTRASONIC SCALER

INSTRUCTION MANUAL

Please read this manual before operating

ZMN-SM-124 V2.0-20231102

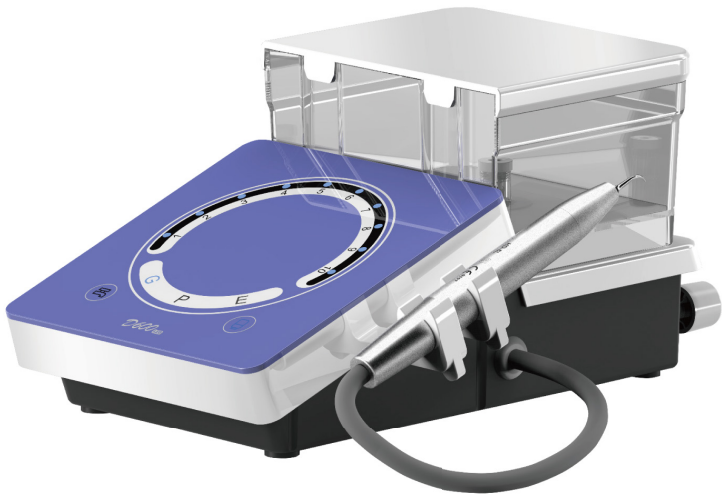

www.glwoodpecker.com

GUILIN WOODPECKER MEDICAL INSTRUMENT CO., LTD.

Contents

1. The installation and components of equipment	1
2. Installation and adjustment	3
3. Maintenance	5
4. Cleaning, Disinfection and Sterilization	9
5. Precaution	15
6. After service	17
7. Symbol instruction	17
8. Environmental protection.....	18
9. Manufacturer's right	18
10. European authorized representative	18
11. EMC - Declaration of conformity	18
12. Statement.....	22
TABLE OF OPERATING POWER OF THE TIPS	23

1. The installation and components of equipment

1.1 Instruction

Guilin Woodpecker Medical Instrument Co., Ltd. is a professional manufacturer in researching, developing and producing ultrasonic scalers. The product is mainly used for teeth cleaning and also an indispensable equipment for teeth disease prevention and treatment.

The ultrasonic scaler D600 LED has scaling, perio functions with the following features:

1.1.1 The handpiece can be autoclaved to high temperature 134°C and high pressure 0.22Mpa.

1.1.2 Automatic frequency tracking ensures that the machine always works on the best frequency and more steadily.

1.1.3 Digital control, easy operation and more efficient for scaling.

1.2 Components

1.2.1 The components of machine are listed in the packing list.

1.2.2 Product performance and structural composition

Ultrasonic scaler D600 LED is composed of electrocircuit, water way and ultrasonic transducer.

1.2.3 Scope of application

Ultrasonic scaler D600 LED is used for the dental calculus elimination and root canal treatment.

1.3 The main technical specifications

1.3.1 Technical specifications of ultrasonic scaler

a) Main unit input: 220-240V~ 50Hz/60Hz 150mA

b) Output primary tip vibration excursion: $\leq 90\mu\text{m}$

c) Output half-excursion force: $< 2\text{N}$

d) Output tip vibration frequency: $28\text{kHz} \pm 3\text{kHz}$

e) Output power: 3W to 20W

f) Main unit fuse: T0.5AL 250V

g) Water pressure: 0.01MPa to 0.5MPa

h) Weight of main unit: 1.8kg

i) Operating mode: Continuous operation

j) Type of protection against electric shock: class II equipment

k) Degree of protection against electric shock: Type BF applied part

l) Applied part of the equipment: handpiece and tip

m) Degree of protection against harmful ingress of water: Ordinary equipment, the foot switch is drip-proof equipment (IPX1)

n) Degree of safety of application in the presence of a Flammable Anesthetic Mixture with air, Oxygen or Nitrous Oxide: Equipment not suitable for being used in the presence of a flammable anesthetic mixture with air, oxygen or nitrous oxide.

1.4 Instruction of the main components

Instruction and component sketch map

1.4.1 Front of the main unit sketch map

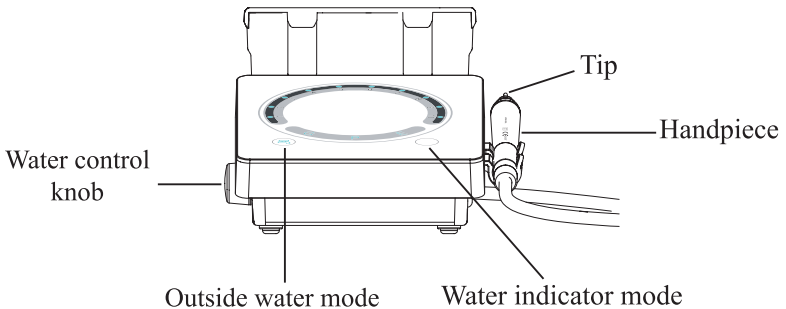

Picture 1

1.4.2 Back of the main unit sketch map

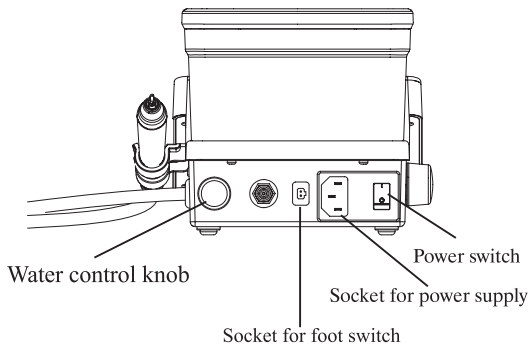

Picture 2

1.4.3 Instruction of using wrench

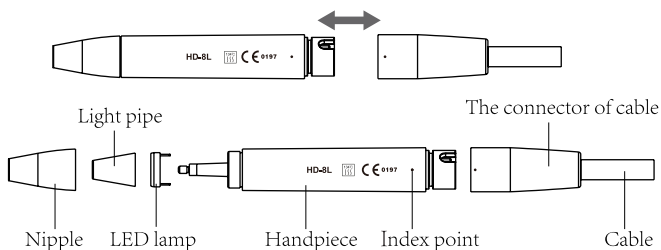

Picture 3

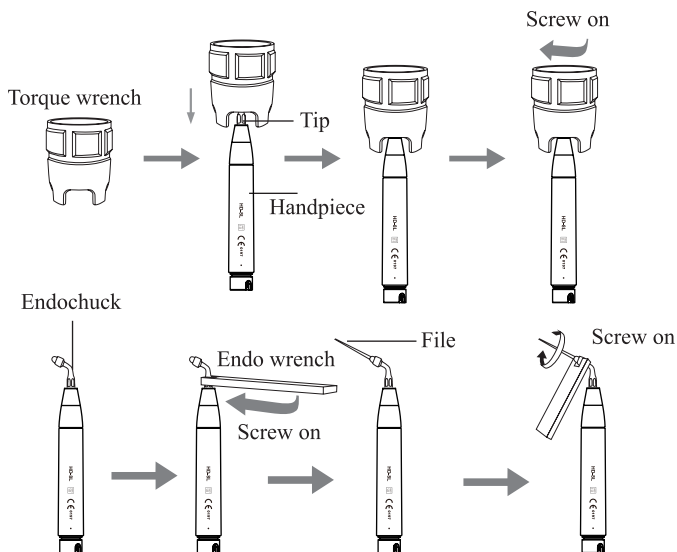

Picture 4

2. Installation and adjustment

2.1 Operation

2.1.1 Open the packing box, make sure that all the parts and accessories are complete according to the packing list, take the main unit

out of the box, and put it on the the stable plane facing to the operator.

2.1.2 Turn the water control knob to the max according to the picture 1 direction, Do not screw it over tight in case of damage. [note 1]

2.1.3 Insert the plug of the foot switch to its socket. (see picture 2)

2.1.4 Connect one end of the water pipe to the water entrance, and the other end to the clean water source. (see picture 2)

2.1.5 Choose the scaling tip according to the requirement, and fix the scaling tip with the wrench. (see picture 4)

2.1.6 Turn on the power switch, the power indicator lighted and the machine is ready for work. Touch panel is applied to this machine, water supply mode or power can be adjusted by directly touching the water supply mode identification or power indicator on the touch panel.

2.1.7 Under normal working condition, the frequency of the tips is very high, light touch and a certain to-and-fro motion will eliminate the tartar without obvious heating, overexertion and overstay are forbidden.

2.1.8 Vibrating intensity: Adjust the vibrating intensity according to your need, usually adjust to the middle grade, and adjust the vibrating during the clinical treatment according to the patient's sensitivity and the rigidity of the tartar.

2.1.9 Step on the foot switch, the tip begins to vibrate, and the LED lamp on the top of the handpiece shines. Release the foot switch, the LED lamp keep shining for 10 seconds.

2.1.10 Water volume adjustment: Step on the foot switch, and the tip begins to vibrate, then turn the water control switch to fine spray to cool down the handpiece and clean the teeth.

2.1.11 The handpiece can be handled in the same gesture as a pen in hand.

2.1.12 Be sure not to make the end of the tip touch the teeth vertically, and not use too much pressure when the tip touch the surface of the teeth, in order not to hurt the teeth and the tip.

2.1.13 After finishing operation, keep the machine working for 30 seconds with the water supply to clean the handpiece and the tip.

2.1.14 Unscrew the scaling tip and sterilize it.

Note: Don't screw the scaling tips when stepping on the foot switch, and the machine is working.

2.2 Cleaning mode

It is suggested to wash and disinfect the water pipe after scaling everyday.

The “Cleaning mode” can wash and disinfect the water pipe, reducing the crystal substance and bacterias in water pipe.

Operation:

1.Put distilled water or mineral substance into water tank.

2.Press the automatically water supply button and outside water button at the same time (1s) to start the “Cleaning mode” after buzzer beeps. The button of automatic water supply mode would flashes and others buttons will go out.

3.Link the connector and the handpiece with the drainage device.

4.Step the pedal, the device would start self-cleaning. After that the pedal could be loosen.

5.After cleaning for 30s, the device would stop self-cleaning. Or u can stop by step the pedal again or press the automatic water supply button.

6.After cleaning, press the automatically water supply button and outside water button at the same time (1s) to exit the “Cleaning mode” after buzzer beeps.

3. Maintenance

3.1 Troubleshooting

Fault	Possible cause	Solutions
The scaling tip doesn't vibrate and there is no water flowing out when stepping on the foot switch.	The power plug is in loose contact.	Make the plug insert to the socket well.
	The foot switch is in loose contact.	Insert the foot switch to its socket tightly.
	The fuse in the main unit is broken.	Contact our dealers or us.

Fault	Possible cause	Solutions
The scaling tip doesn't vibrate but there is water flowing out when stepping on the switch.	The tip is in loose contact.	Screw the tip on the handpiece tightly (See Picture 6).
	The connect plug between the handpiece and the circuit board is in loose contact.	Contact our dealers or us.
	Something wrong with the handpiece.	Send the handpiece to our company to repair.
	Something wrong with the cable.	Contact our dealers or us.
The scaling tip vibrates but there is no spray when stepping on the foot switch.	The water control knob is not on.	Turn on the water control knob [note 1].
The vibration of the tip becomes weak.	The tip hasn't been screwed on to the handpiece tightly.	Screw the tip on the handpiece tightly (See Picture 4).
	The tip is loose because of vibration.	Screw on the tip tightly (See Picture 4).
	The coupling between the handpiece and the cable isn't dry.	Dry it by the hot air.
	The tip is damaged [note 2].	Change a new one.
There is water seeping from the coupling between the handpiece and cable.	The waterproof "O"ring is damaged.	Change a new waterproof "O"ring.
There is water flow out when turn off the power.	There is impurity in the solenoid valve.	Contact with the local distributor or manufacturer.

Fault	Possible cause	Solutions
The handpiece generates heat.	The amount of spouting water is too little.	Turn the water control switch to a higher grade [note 1].
	The potentiometer is broken.	Change a new one.
The amount of spouting water is too little.	The water control knob is a low grade.	Turn the knob to a high grade [note 1].
	The water pressure is not enough.	Enhance the water pressure.
	The water pipe is jammed.	Clean water pipe with multi-function syringe [note2].
The vibrating intensity control knob is seized up.	The potentiometer is damaged.	Contact with the local distributor or our company.
The u-file doesn't vibrate.	The screw is loose.	Tighten it.
	Endochuck is damaged.	Change a new one.
There is noise coming from the endochuck.	The screw is loose.	Tighten it.
LED light don't work	Poor contact	Contact tightly
	Something wrong with LED light	Change a new one
There is no water coming out from the handpiece (automatic water supply mode).	There is air in the water pipe.	Turn the water control to the Max, reinsert the bottle.

If the problem still can't be solved, please contact with local dealer or manufacturer.

3.2 Notice

[Note 1] The water control knob can adjust the water volume according to the symbol.

[Note 2] To clean the water pipe with the multi-function syringe of the dental unit (see picture 5):

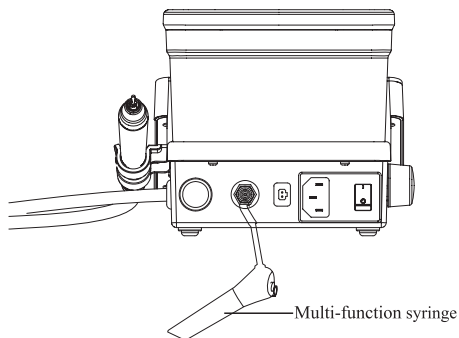

picture 5

- a) Snip the water pipe at a distance of 10cm to 20cm from the water entrance.
- b) Turn on the power switch, get through to the power.
- c) Connect the multi-function syringe of the dental unit to the water pipe.
- d) Screw off the scaling tip or pull out the handpiece.
- e) Step on the foot switch.
- f) Turn on the switch of the multi-function syringe, press the air or water into the water pipe to clean and eliminate the impurity.

[Note 3] If the scaling tip has been screwed on tightly and there is fine spray too, the following phenomena show that the scaling tip is damaged:

- a) The vibrating intensity and the pulverization degree become weak obviously.
- b) During operating, there is some buzz when the scaling tip is working.

3.3 Cleaning mode

The liquid pipeline of the machine must be rinsed after each use of the clinical liquid to reduce the crystal accumulation and the bacteria in the liquid pipe.

Operation

1. Put distilled water or mineral substance into water tank.
2. Press the automatically water supply button and outside water button at the same time (1s) to start the “Cleaning mode” after buzzer begins. The button of automatic water supply mode would flashes and

others buttons will go out.

3.Link the connector and the handpiece with the drainage device.

4.Step the pedal, the device would start self-cleaning. After that the pedal could be loosen.

5.After cleaning for 30s, the device would stop self-cleaning. Or u can stop by step the pedal again or press the automatic water supply button.

6.After cleaning, press the automatically water supply button and outside water button at the same time (1s) to exit the “Cleaning mode” after buzzer beeps.

4. Cleaning, Disinfection and Sterilization

The cleaning, disinfection and sterilization of handpiece, tip, and wrench (include torque wrench and Endo wrench) are as follow.

Unless otherwise stated, they will be hereinafter referred to as “products”.

Warnings

The use of strong detergent and disinfectant (alkaline pH>9 or acid pH <5) will reduce the life span of products. And in such cases, the manufacturer takes no responsibility.

Do not clean the handpiece with ultrasound cleaning machine.

This device shall not be exposed to high temperature above 138°C.

Processing limit

The products have been designed for a large number of sterilization cycles. The materials used in manufacture were selected accordingly. However with every renewed preparation for use, thermal and chemical stresses will result in ageing of the products. The maximum number of sterilizations for handpiece is 600 times. For tips, it is 300 times. And for wrench, it is 1000 times.

4.1 Initial processing

4.1.1 Processing principles

It is only possible to carry out effective sterilization after the completion of effective cleaning and disinfection. Please ensure that, as part of your responsibility for the sterility of products during use, only sufficiently validated equipment and product-specific procedures are used for cleaning/disinfection and sterilization, and that the validated parameters are adhered to during every cycle.

Please also observe the applicable legal requirements in your country

as well as the hygiene regulations of the hospital or clinic, especially with regard to the additional requirements for the inactivation of prions.

4.1.2 Post-operative treatment

The post-operative treatment must be carried out immediately, no later than 30 minutes after the completion of the operation. The steps are as follows:

1. Let the Ultrasonic scaler works for 20-30 seconds under irrigation mode to flush the handpiece and tip;
2. Remove the handpiece from the Ultrasonic scaler, and rinse away the dirt on the surface of product with pure water (or distilled water/deionized water);
3. Dry the product with a clean, soft cloth and place it in a clean tray.

Notes

a) The water used here must be pure water, distilled water or deionized water.

4.2 Preparation before cleaning

Steps

Tools: Torque wrench, tray, soft brush, clean and dry soft cloth.

1. Remove the tip from product with torque wrench provided by Guilin Woodpecker Medical Instrument Co., Ltd, and then put the tip and wrench into a clean tray.

2. Unscrew the nipple of product counterclockwise, remove the sealing ring, light pipe (if any), and LED lamp(if any), and put them in the tray.

3. Use a clean soft brush to carefully brush the joints between product and the connector of cable, front thread, horn, nipple, seal ring, light pipe (if any) and LED lamp(if any) until the dirt on surface is not visible. Then use soft cloth to dry the product and accessories and put them into a clean tray. The cleaning agent can be pure water, distilled water or deionized water.

Disassembling steps

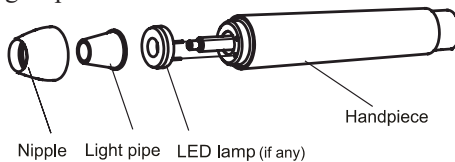

4.3 Cleaning

The cleaning should be performed no later than 24 hours after the

operation.

The cleaning can be divided into automated cleaning and manual cleaning. Automated cleaning is preferred if conditions permit.

4.3.1 Automated cleaning

- The cleaner is proved to be valid by CE certification in accordance with EN ISO 15883.

- There should be a flushing connector connected to the inner cavity of the product.

- The cleaning procedure is suitable for the product, and the irrigating period is sufficient.

- Do not clean the handpiece with ultrasound.

It is recommended to use a washer-disinfector in accordance with EN ISO 15883. For the specific procedure, please refer to the automated disinfection section in the next section “Disinfection”.

Notes

a) The cleaning agent does not have to be pure water. It can be distilled water, deionized water or multi-enzyme. But please ensure that the selected cleaning agent is compatible with the product.

b) In washing stage, the water temperature should not exceed 45 °C, otherwise the protein will solidify and it would be difficult to remove.

c) After cleaning, the chemical residue should be less than 10mg / L.

4.4 Disinfection

Disinfection must be performed no later than 2 hours after the cleaning phase. Automated disinfection is preferred if conditions permit.

4.4.1 Automated disinfection-Washer-disinfector

- The washer-disinfector is proved to be valid by CE certification in accordance with EN ISO 15883.

- Use high temperature disinfection function. The temperature does not exceed 134 ° C, and the disinfection under the temperature cannot exceed 20 minutes.

- The disinfection cycle is in accordance with the disinfection cycle in EN ISO 15883.

Cleaning and disinfecting steps by using Washer-disinfector

1. Carefully place the product into the disinfection basket. Fixation of product is needed only when the product is removable in the device. The products are not allowed to contact each other.

2. Use a suitable rinsing adaptor, and connect the internal water lines to the rinsing connection of the washer-disinfector.

3. Start the program.

4. After the program is finished, remove the product from the washer-disinfector, inspect (refer to section “Inspection and Maintenance”) and packaging (refer to chapter “Packaging”). Dry the product repeatedly if necessary (refer to section “Drying”).

Notes

a) Before use, you must carefully read the operating instructions provided by the equipment manufacturer to familiarize yourself with the disinfection process and precautions.

b) With this equipment, cleaning, disinfection and drying will be carried out together.

c) Cleaning: (c1) The cleaning procedure should be suitable for the product to be treated. The flushing period should be sufficient (5-10 minutes). Pre-wash for 3 minutes, wash for another 5 minutes, and rinse it for twice with each rinse lasting for 1 minute. (c2) In the washing stage, the water temperature should not exceed 45 °C, otherwise the protein will solidify and it is difficult to remove. (c3) The solution used can be pure water, distilled water, deionized water or multi-enzyme solution, etc., and only freshly prepared solutions can be used. (c4) During the use of cleaner, the concentration and time provided by manufacturer shall be obeyed. The used cleaner is neodisher MediZym (Dr. Weigert).

d) Disinfection: (d1) Direct use after disinfection: temperature ≥ 90 °C, time ≥ 5 min or $A0 \geq 3000$.

(d2) Sterilize it after disinfection and use: temperature ≥ 90 °C, time ≥ 1 min or $A0 \geq 600$.

(d3) For the disinfection here, the temperature is 93 °C, the time is 2.5 min, and $A0 > 3000$.

e) Only distilled or deionized water with a small amount of microorganisms (< 10 cfu/ml) can be used for all rinsing steps. (For example, pure water that is in accordance with the European Pharmacopoeia or the United States Pharmacopoeia).

f) After cleaning, the chemical residue should be less than 10mg / L.

g) The air used for drying must be filtered by HEPA.

h) Regularly repair and inspect the disinfector.

4.5 Drying

If your cleaning and disinfection process does not have an automatic drying function, dry it after cleaning and disinfection.

Methods

1. Spread a clean white paper (white cloth) on the flat table, point the product against the white paper (white cloth), and then dry the product with filtered dry compressed air (maximum pressure 3 bar). Until no liquid is sprayed onto the white paper (white cloth), the product drying is completed.

2. It can also be dried directly in a medical drying cabinet (or oven). The recommended drying temperature is 80°C~120°C and the time should be 15~40 minutes.

Notes

- a) The drying of product must be performed in a clean place.
- b) The drying temperature should not exceed 138 °C;
- c) The equipment used should be inspected and maintained regularly.

4.6 Inspection and maintenance

In this chapter, we only check the appearance of the product. After inspection, if there is no problem, the handpiece should be immediately reassembled, installing the sealing ring, LED, light guide, and cone head in sequence to the handpiece, and then tighten the cone head clockwise.

4.6.1 Check the product. If there is still visible stain on the product after cleaning/disinfection, the entire cleaning/disinfection process must be repeated.

4.6.2 Check the product. If it is obviously damaged, smashed, detached, corroded or bent, it must be scrapped and not allowed to continue to be used.

4.6.3 Check the product. If the accessories are found to be damaged, please replace it before use. And the new accessories for replacement must be cleaned, disinfected and dried.

4.6.4 If the service time (number of times) of the product reaches the specified service life (number of times), please replace it in time.

4.7 Packaging

Install the disinfected and dried product and quickly package it in a medical sterilization bag (or special holder, sterile box).

Notes

- a) The package used conforms to ISO 11607;
- b) It can withstand high temperature of 138 °C and has sufficient steam permeability;
- c) The packaging environment and related tools must be cleaned regularly to ensure cleanliness and prevent the introduction of

contaminants;

d) Avoid contact with parts of different metals when packaging.

4.8 Sterilization

Use only the following steam sterilization procedures (fractional pre-vacuum procedure*) for sterilization, and other sterilization procedures are prohibited:

- The steam sterilizer complies with EN13060 or is certified according to EN 285 to comply with EN ISO 17665;
- The highest sterilization temperature is 138 °C;
- The sterilization time is at least 4 minutes at a temperature of 132°C/134°C and a pressure of 2.0 bar ~ 2.3 bars.
- Allow a maximum sterilization time of 20 minutes at 134 °C.

Verification of the fundamental suitability of the products for effective steam sterilization was provided by a verified testing laboratory.

Notes

a) Only products that have been effectively cleaned and disinfected are allowed to be sterilized;

b) Before using the sterilizer for sterilization, read the Instruction Manual provided by the equipment manufacturer and follow the instructions.

c) Do not use hot air sterilization and radiation sterilization as this may result in damage to the product;

d) Please use the recommended sterilization procedures for sterilization. It is not recommended to sterilize with other sterilization procedures such as ethylene oxide, formaldehyde and low temperature plasma sterilization. The manufacturer assumes no responsibility for the procedures that have not been recommended. If you use the sterilization procedures that have not been recommended, please adhere to related effective standards and verify the suitability and effectiveness.

* Fractional pre-vacuum procedure = steam sterilization with repetitive pre-vacuum. The procedure used here is to perform steam sterilization through three pre-vacuums.

4.9 Storage

1 Store in a clean, dry, ventilated, non-corrosive atmosphere with a relative humidity of 10% to 93%, an atmospheric pressure of 70KPa to 106KPa, and a temperature of -20 °C to +55 °C;

2 After sterilization, the product should be packaged in a medical sterilization bag or a clean sealing container, and stored in a special

storage cabinet. The storage time should not exceed 7 days. If it is exceeded, it should be reprocessed before use.

Notes:

a) The storage environment should be clean and must be disinfected regularly;

b) Product storage must be batched and marked and recorded.

4.10 Transportation

1. Prevent excessive shock and vibration during transportation, and handle with care;

2. It should not be mixed with dangerous goods during transportation.

3. Avoid exposure to sun or rain or snow during transportation.

The cleaning and disinfection of main unit are as follows.

- Before each use, wipe the surface of the connector of cable and cable with a soft cloth or paper towel soaked in 75% medical alcohol. Repeat the wipe for at least 3 times.

- Before each use, please let the Ultrasonic scaler work under irrigation mode for 20-30s, then install the handpiece.

- After each use, please let the Ultrasonic scaler work under irrigation mode for 20-30s, then remove the handpiece.

- After each use, wipe the surface of the connector of cable and cable with a soft cloth soaked in clean water (distilled or deionized water) or a clean disposable wipe. Repeat the wipe for at least 3 times.

5. Precaution

5.1 usage notice

5.1.1 Keep the scaler clean before and after operation.

5.1.2 The scaling tip, wrench and handpiece must be sterilized before each treatment.

5.1.3 Don't screw the scaling tip when stepping on the foot switch.

5.1.4 The scaling tip must be fastened. There must be fine spray coming out from the tip when operating.

5.1.5 Change a new one when the tip is damaged or worn excessively.

5.1.6 Don't twist or rub the tip.

5.1.7 While scaler working, the heat of scaling tip will become higher if there is no water flowing out, please keep the water flow smoothly.

5.1.8 Don't use impure water source, and be sure not to use normal brine instead of pure water source.

5.1.9 If use the water source without hydraulic pressure, the water

surface should be one meter higher than the head of the patient.

5.1.10 Don't knock or rub the handpiece.

5.4.11 After each clinical operation with clinical liquid, change a bottle with purified water, turn the water supply to max, make the machine work with auto-water supply for 30 seconds in order to keep the water way and spare parts clean and durable.

5.1.12 Please put the power plug into the socket easy to pull out, to make sure it can be pull out in emergency.

5.1.13 When using the equipment, please keep the water get through smoothly, otherwise patient's tooth surface would be injured by overheat in the handpiece.

5.1.14 After operating, turn off electrical source, and then pull out the plug.

5.1.15 As a professional manufacturer of medical instruments, we are only responsible for the safety on the following conditions:

I . The maintenance, repair and modification are made by the manufacturer or the authorized dealer.

II . The changed components are original of "DTE" and operated correctly according to instruction manual.

5.1.16 The screw thread of the scaling tips produced by other manufacturers maybe coarse, rusty and collapsed, which will damage the screw thread of the handpiece irretrievably. Please use "WOODPECKER" brand scaling tip.

5.1.17 Please select a suitable power when using different type of tips (refer to "TABLE OF OPERATING POWER OF THE TIPS").

5.2 Contraindication

5.2.1 The patient who has hemophilia is not allowed to use this equipment.

5.2.2 The patient or doctor who with heart pacemaker is forbidden to use this equipment.

5.2.3 The heart disease patient, pregnant woman and children should be cautious to use the equipment.

5.3 Storage and maintenance

5.3.1 The equipment should be handled carefully and lightly. Be sure that it is far from the vibration, and is installed or kept in a cool, dry and ventilated place.

5.3.2 Don't store the machine together with the articles that are combustible poisonous, caustic, or explosive.

5.3.3 This equipment should be stored in a room where the relative humidity is 10% ~ 93%, atmospheric pressure is 70kPa to 106kPa, and the temperature is -20°C ~ +55°C.

5.3.4 Please turn off the power switch and pull out the power plug when the equipment is not used. If the machine is not used for a long time, please make it get through to the power and water once per month for five minutes.

5.4 Transportation

5.4.1 Excessive impact and shake should be prevented in transportation. Lay it carefully and lightly and don't invert it.

5.4.2 Don't put it together with dangerous goods during transportation.

5.4.3 Avoid solarization and getting wet in rain or snow during transportation.

5.5 Working condition

5.5.1 Environment temperature: +5°C to +40°C

5.5.2 Relative humidity: 30%~75%

5.5.3 Atmosphere pressure: 70kPa to 106kPa

5.5.4 A temperature of the water at the inlet: not higher than +25° C

6. After service

We offer two year free repair to the equipment according to the warranty card.

The repair of the equipment should be carried out by professional technician. We are not responsible for any irretrievable damage caused by the not professional person.

7. Symbol instruction



Appliance compliance
WEEE directive



Alternating current



Date of manufacture



Class II equipment

IPX0

Ordinary equipment

IPX1

Drip-proof



Manufacturer



Type BF applied part



Foot switch interface



Used indoor only



Adjustment for the water flow



Sterilizable up to the temperature specified



Mode of outside-water system



Mode of auto-water system

H_2O
0.01Mpa-0.5MPa

Water entrance pressure



Earth (ground)



CE marked product



Follow Instructions for Use



Adjustment for the water flow, in Mode of auto-water system



Atmospheric pressure for storage



Temperature limitation for storage



Humidity limitation for storage



Authorised Representative in the EUROPEAN COMMUNITY

8. Environmental protection

Please dispose according to the local laws.

9. Manufacturer's right

We reserve the rights to change the design of the equipment, the technique, fittings, the instruction manual and the content of the original packing list at any time without notice. If there are some differences between blueprint and real equipment, take the real equipment as the norm.

10. European authorized representative



MedNet EC-Rep GmbH
Borkstrasse 10 · 48163 Muenster · Germany

11. EMC - Declaration of conformity

The device has been tested and homologated in accordance with EN 60601-1-2 for EMC. This does not guarantee in any way that this device will not be effected by electromagnetic interference Avoid using the device in high electromagnetic environment.

Guidance and manufacturer's declaration - electromagnetic emissions		
The models D600, D600 LED are intended for use in the electromagnetic environment specified below. The customer or the user of the models D600, D600 LED should assure that it is used in such an environment.		
Emissions test	Compliance	Electromagnetic environment - guidance
RF emissions CISPR 11	Group 1	The models D600, D600 LED use RF energy only for its internal function. Therefore, its RF emissions are very low and are not likely to cause any interference in nearby electronic equipment.
RF emissions CISPR11	Class B	The models D600, D600 LED are suitable for used in domestic establishment and in establishment directly connected to a low voltage power supply network which supplies buildings used for domestic purposes.
Harmonic emissions IEC 61000-3-2	Class A	
Voltage fluctuations / flicker emissions IEC 61000-3-3	Complies	

Guidance & Declaration — electromagnetic immunity			
The models D600, D600 LED are intended for use in the electromagnetic environment specified below. The customer or the user of the models D600, D600 LED should assure that It is used in such an environment.			
Immunity test	IEC 60601 test level	Compliance level	Electromagnetic environment - guidance
Electrostatic discharge (ESD) IEC 61000-4-2	±8 kV contact ±2 kV, ±4 kV, ±8 kV, ±15 kV air	±8 kV contact ±2 kV, ±4 kV, ±8 kV, ±15 kV air	Floors should be wood, concrete or ceramic tile. If floors are covered with synthetic material, the relative humidity should be at least 30 %.
Electrical fast transient/burst IEC 61000-4-4	±2kV for power supply lines ±1 kV for Input/ output lines	±2kV for power supply lines ±1kV for interconnecting cable	Mains power quality should be that of a typical commercial or hospital environment.
Surge IEC 61000-4-5	±1 kV line to line ±2 kV line to earth	±1 kV line to line	Mains power quality should be that of a typical commercial or hospital environment.

Voltage dips, short interruptions and voltage variations on power supply input lines IEC 61000-4-11.	<5 % UT (>95% dip in UT.) for 0.5 cycle 40 % UT (60% dip in UT) for 5 cycles 70% UT (30% dip in UT) for 25 cycles <5% UT (>95 % dip in UT) for 5 sec	<5 % UT (>95% dip in UT.) for 0.5 cycle 40 % UT (60% dip in UT) for 5 cycles 70% UT (30% dip in UT) for 25 cycles <5% UT (>95 % dip in UT) for 5 sec	Mains power quality should be that of a typical commercial or hospital environment. If the user of the models D600, D600 LED require continued operation during power mains interruptions, it is recommended that the models D600, D600 LED be powered from an uninterruptible power supply or a battery.
Power frequency (50/60 Hz) magnetic field IEC 61000-4-8	30A/m	30A/m	Power frequency magnetic fields should be at levels characteristic of a typical location in a typical commercial or hospital environment.
NOTE U_T is the a.c. mains voltage prior to application of the test level.			

Guidance & Declaration - Electromagnetic immunity

The models D600, D600 LED are intended for use in the electromagnetic environment specified below. The customer or the user of the models D600, D600 LED should assure that it is used in such an environment.

Immunity test	IEC 60601 test level	Compliance level	Electromagnetic environment - guidance
----------------------	-----------------------------	-------------------------	---

<p>Conducted RF IEC 61000-4-6</p>	<p>3 Vrms 150 kHz to 80 MHz</p>	<p>3 Vrms</p>	<p>Portable and mobile RF communications equipment should be used no closer to any part of the models D600, D600 LED, including cables, than the recommended separation distance calculated from the equation applicable to the frequency of the transmitter.</p> <p>Recommended separation distance</p> $d = [3.5/V1] \times P^{1/2}$ <p>$d = 1.2 \times P^{1/2}$ 80 MHz to 800 MHz $d = 2.3 \times P^{1/2}$ 800 MHz to 2.5 GHz</p> <p>where P is the maximum output power rating of the transmitter in watts (W) according to the transmitter manufacturer and d is the recommended separation distance in meters (m).</p> <p>Field strengths from fixed RF transmitters, as determined by an electromagnetic site survey,^a should be less than the compliance level in each frequency range.^b</p> <p>Interference may occur in the vicinity of equipment marked with the following symbol:</p> 
<p>Radiated RF IEC 61000-4-3</p>	<p>3 V/m 80 MHz to 2.5 GHz</p>	<p>3 V/m</p>	

NOTE 1 At 80 MHz end 800 MHz. the higher frequency range applies.

NOTE 2 These guidelines may not apply in all situations. Electromagnetic propagation is affected by absorption and reflection from structures, objects and people.

^a Field strengths from fixed transmitters, such as base stations for radio (cellular/cordless) telephones and land mobile radios, amateur radio, AM and FM radio broadcast and TV broadcast cannot be predicted theoretically with accuracy. To assess the electromagnetic environment due to fixed RF transmitters, an electromagnetic site survey should be considered. If the measured field strength in the location in which the models D600, D600 LED are used exceeds the applicable RF compliance level above, the model D600, D600 LED should be observed to verify normal operation. If abnormal performance is observed, additional measures may be necessary, such as reorienting or relocating the models D600, D600 LED.

^b Over the frequency range 150 kHz to 80 MHz, field strengths should be less than 3V/m.

Recommended separation distances between portable and mobile RF communications equipment and the models D600, D600 LED

The models D600, D600 LED are intended for use in electromagnetic environment in which radiated RF disturbances is controlled. The customer or the user of the models D600, D600 LED can help prevent electromagnetic interference by maintaining a minimum distance between portable and mobile RF communications equipment (transmitters) and the models D600, D600 LED are recommended below, according to the maximum output power of the communications equipment.

Rated maximum output power of transmitter W	Separation distance according to frequency of transmitter m		
	150kHz to 80MHz $d=1.2 \times P^{1/2}$	80MHz to 800MHz $d=1.2 \times P^{1/2}$	800MHz to 2,5GHz $d=2.3 \times P^{1/2}$
0.01	0.12	0.12	0.23
0.1	0.38	0.38	0.73
1	1.2	1.2	2.3
10	3.8	3.8	7.3
100	12	12	23

For transmitters rated at a maximum output power not listed above, the recommended separation distance d in meters (m) can be estimated using the equation applicable to the frequency of the transmitter, where P is the maximum output power rating of the transmitter in watts (W) accordable to the transmitter manufacturer.

NOTE 1 At 80 MHz and 800 MHz. the separation distance for the higher frequency range applies. NOTE 2 These guidelines may not apply in all situations. Electromagnetic propagation is affected by absorption and reflection from structures, objects and people.

12. Statement

All rights of modifying the product are reserved to the manufacturer without further notice. The pictures are only for reference. The final interpretation rights belong to GUILIN WOODPECKER MEDICAL INSTRUMENT CO., LTD. The industrial design, inner structure, etc, have claimed for several patents by WOODPECKER, any copy or fake product must take legal responsibilities.

TABLE OF OPERATING POWER OF THE TIPS

Scaling	
Tip Model	Power
GD3	1-10(G)
GD4	1-10(G)
GD4D	1-10(G)
GD5	1-10(G)
GD6	1-10(G)
GD7	1-10(G)
GD8	1-10(G)
GD9	1-10(G)
GD10	1-10(G)
GD11	1-10(G)
GD12	1-10(G)
GD30	1-10(G)

Periodontics	
Tip Model	Power
PD1	1-10(P)
PD2L	1-3(P)
PD2LD	1-2(P)
PD2R	1-3(P)
PD2RD	1-2(P)
PD3	1-6(P)
PD3D	1-6(P)
PD4	1-6(P)
PD4D	1-6(P)
PD7	1-10(P)
PD12	1-10(P)

Endodontics	
Tip Model	Power
ED3	1-6(E)
ED3D	1-3(E)
ED4	1-6(E)
ED4D	1-3(E)
ED5	1-6(E)
ED5D	1-3(E)
ED6	1-6(E)
ED7	1-6(E)
ED8	1-10(E)
ED9	1-10(E)
ED10	1-6(E)
ED10D	1-6(E)
ED11	1-6(E)
ED11D	1-6(E)
ED12	1-6(E)
ED12D	1-6(E)
ED14	1-3(E)
ED15	1-3(E)

Cavity Preparation	
Tip Model	Power
SBD1	1-10(P)
SBD2	1-10(P)
SBD3	1-10(P)
SBDL	1-10(P)
SBDR	1-10(P)

Scan and Login website
for more information



Guilin Woodpecker Medical Instrument Co.,Ltd.

Information Industrial Park, Guilin National High-Tech
Zone, Guilin, Guangxi, 541004 P. R. China

Sales Dept.: +86-773-5873196/2350599

After-sales Service Dept.: 0773-5827898

E-mail: woodpecker4@glwoodpecker.com

Website: <http://www.glwoodpecker.com>



MedNet EC-Rep GmbH
Borkstrasse 10 · 48163 Muenster · Germany

Ultrasonic Scaler Warranty Card

Name of Customer		(I) For Customer
Address Details		
Postal Code		
Tel		
Model		
Product No.		
Handpiece No.		
Purchase Date		
Contact Person		
Date	Maintenance Record	Repairer

 **Guilin Woodpecker Medical Instrument Co., Ltd.**
 Information Industrial Park, Guilin National High-Tech Zone, Guilin, Guangxi, 541004 P. R. China

Europe Sales Dept. Tel: +86-773-5873196, 2125222
North America, South America & Oceania Sales Dept. Tel: +86-773-5873198, 2125123
Asia & Africa Sales Dept. Tel: +86-773-5855350, 2125896
Fax: +86-773-5822450
E-mail: woodpecker@glwoodpecker.com, sales@glwoodpecker.com
Website: http://www.glwoodpecker.com

Distributor:	Seal
--------------	------

Ultrasonic Scaler Warranty Card

Name of Customer		(II) For Distributor
Address Details		
Postal Code		
Tel		
Model		
Product No.		
Handpiece No.		
Purchase Date		
Contact Person		
Date	Maintenance Record	Repairer

 **Guilin Woodpecker Medical Instrument Co., Ltd.**
 Information Industrial Park, Guilin National High-Tech Zone, Guilin, Guangxi, 541004 P. R. China

Europe Sales Dept. Tel: +86-773-5873196, 2125222
North America, South America & Oceania Sales Dept. Tel: +86-773-5873198, 2125123
Asia & Africa Sales Dept. Tel: +86-773-5855350, 2125896
Fax: +86-773-5822450
E-mail: woodpecker@glwoodpecker.com, sales@glwoodpecker.com
Website: http://www.glwoodpecker.com

Distributor:	Seal
--------------	------

Warranty Instruction

I Period validity:

Two year's free repair for the whole unit (except for the easily-consumed parts) from the date of purchase. Lifetime maintenance.

II Range of warranty:

Within the warranty period of validity, we are responsible for any troubles caused by quality problems or products technique and structure.

III The following are beyond our warranty:

1. The damage caused by disobeying the operation instruction or lack of the needed condition.
2. The damage caused by unsuitable operation or disassembly without authorization.
3. The damage caused by unadvisable transportation or preservation.
4. There isn't the seal of distributor or the warranty card isn't filled in completed.

Warranty Instruction

I Period validity:

Two year's free repair for the whole unit (except for the easily-consumed parts) from the date of purchase. Lifetime maintenance.

II Range of warranty:

Within the warranty period of validity, we are responsible for any troubles caused by quality problems or products technique and structure.

III The following are beyond our warranty:

1. The damage caused by disobeying the operation instruction or lack of the needed condition.
2. The damage caused by unsuitable operation or disassembly without authorization.
3. The damage caused by unadvisable transportation or preservation.
4. There isn't the seal of distributor or the warranty card isn't filled in completed.

Harm of fake products



and **DTE** are two brands of Guilin woodpecker medical instrument company. Recently, growing fake ultrasonic scaler handpieces, tips curing lights are produced and sold on the market, which do harm to users' interest. On this issue, We Woodpecker will crack down fake products and provide safe and secure medical instrument products.

1. Harm of fake ultrasonic scaler handpieces.

- 1.1 Fake handpieces with poor-designed inner structure can lead to frequent power leakage, which may cause medical accidents.
- 1.2 Material used on fake handpieces don't pass biocompatible test, which can easily lead to irritability and poisoning.
- 1.3 Fake handpieces have quality problems of overheating, non-vibration and cracking, which cause ultrasonic scalers out of order.
- 1.4 Fake handpieces can't be compatible with ultrasonic scalers, thus leading to circuit burn out.

2. Harm of fake scaler tips.

- 2.1 Fake tips are low in toughness, poor in resistance and easy to crack, thus easily cause medical accident.
- 2.2 Fake tips' screw threads are roughly processed, which can cause handpiece's screw loosening and cracking.
- 2.3 Material used on fake tips is inferior and easily rusting, which can cause infection of patient.
- 2.4 Fake tips have used problem of poor water-spraying, bad screw-thread fit and water leaking, which leads ultrasonic scalers work wrongly.

3. Harm of fake curing light.

- 3.1 Fake curing light's batteries can cause self-ignite, even explosion with poor-quality material and no complete charging management.
- 3.2 Light intensity of fake curing light is not constant, when battery level goes down under 60%, it would lead to incomplete solidification of resin, causing secondary dental caries.

